

RG-355

CERTIFIED: EUROCOPTER



TURBINE STARTING AIRCRAFT BATTERY

TSO AUTHORIZED

RG-355 Specifications

Voltage	24 Volts
Rated Capacity C ₁	17 AH
Maximum Weight	41.5 LB / 18.8 KG

Specifications are subject to change without notice

IEC Rated for Peak Power (IPP) & 15 Second Power Rating (IPR)

IPP	IPR	IPP	IPR	IPP	IPR
At 23° C (74° F)		At -18° C (0° F)		At -30° C (-22° F)	
900 A	625 A	600 A	425 A	450 A	300 A

Rated in accordance with International Standard 60952-1

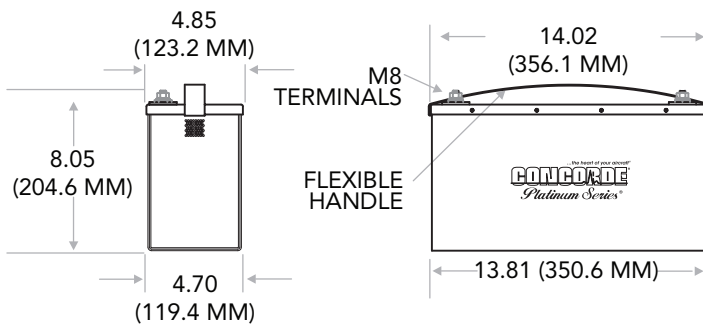

Concorde Battery Corporation

2009 San Bernardino Road, West Covina, CA 91790 USA
Phone 626-813-1234 | Fax 626-813-1235

ISO 9001 + AS9100

The data/information contained herein has been reviewed & approved for general release on the basis that this document contains no export controlled information.

www.concordebattery.com

Concorde is a world leader in valve regulated lead acid (VRLA) aircraft batteries. Designed with advanced lead acid technology, the RG® Series (recombinant gas) is constructed with proprietary PolyGuard® separators and AGM (absorbed glass mat) technology that has been adopted by U.S. and Foreign Military Air Forces. Concorde's proven reliability and excellent performance has resulted in more certified installations as Original Equipment or Replacements than any other lead acid aircraft battery manufacturer worldwide.

Concorde batteries are engineered by a staff of experts with the distinction of having been selected to write military aircraft battery specifications and participate in setting FAA and International Aircraft Battery Standards. Outstanding Customer Support is provided by a professional staff with decades of experience in aircraft systems and the aircraft battery industry.

- Superior starting power in hot & cold climates.
- Reliable essential power in the event of a generator failure.
- Larger intercell connections optimize outrush current flow & increase charge acceptance.
- Low impedance design.
- Proprietary PolyGuard® separators between the plates for added protection against shock & vibration.
- Non removable vent valves, water replenishment is never required – ever.
- No threat of thermal runaway & no deep cycling.
- Fully serviced, tested & ready for installation when shipped from the factory.
- Non-spillable at any attitude.
- Ship Hazmat Exempt whether by land, sea or air.

Worldwide network of professional distributors.